

Hyperboloid Lens Antenna with a Cylindrical Waveguide Feeder

Lenses are used to collimate incident energy to prevent it from spreading in undesired directions. Hyperboloid lenses are used in radar systems and communication multibeam systems.

The hyperboloid lens used in this example is of convex-plane type. That means that one side of lens is hyperboloid, while the other side (toward radiation direction) is a planar.

Waveguide used in this project is specially designed to suppress back radiation. That was done by adding a choke to horn aperture edge. Length of choke is equal to quarter of free-space wavelength.

This kind of waveguide is used in satellite systems, radar application, etc. It is usually used as a feeder for a reflector-type or lens-type antenna system.

Main characteristics of hyperboloid lenses are:

- They are electrically large,
- Dielectric lens influences the signal transition.

An antenna model which consists of hyperboloid lens and cylindrical waveguide feeder, simulated using WIPL-D Pro 3D EM solver, is presented here. Full model is shown in Fig. 1.

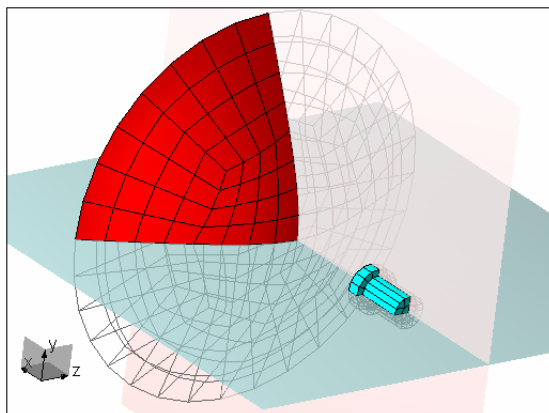
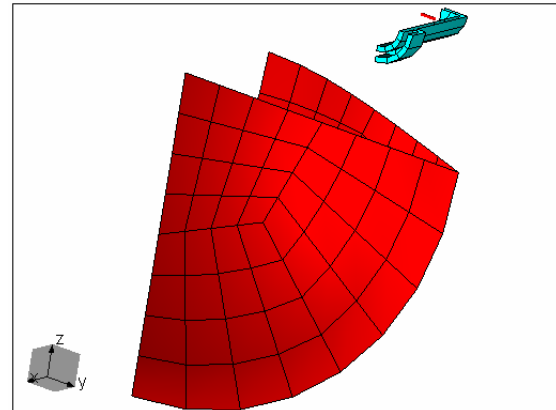

Figure 1. Hyperboloid lens and waveguide feeder

Quarter model, where dielectric layer can be clearly seen, is shown in Fig. 2, while model of the waveguide feeder is shown in Fig. 3.

Our aim is to inspect simulation time and memory requirements, radiation pattern and near field.



a)

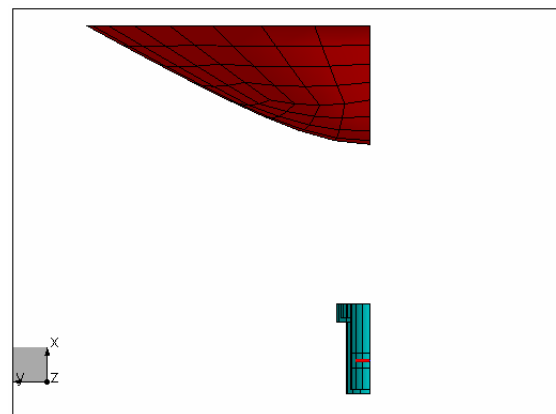

b)

Figure 2. Quarter model of hyperbolic lens and cylindrical waveguide: a) isometric projection, b) z-projection

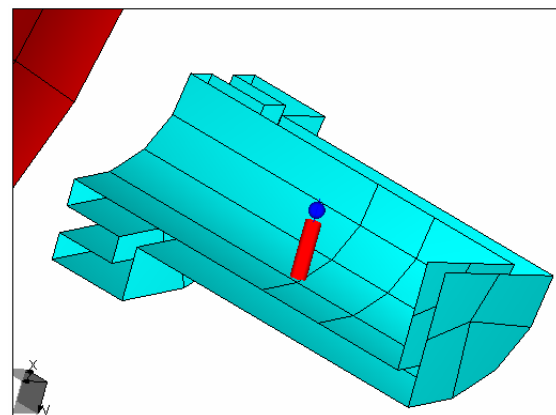

Figure 3. Cylindrical waveguide feeder

WIPL-D Simulation

Operating frequency is 25.5 GHz (K band – NATO band classification).

Antenna shown in Fig.1, can be modeled using WIPL-D Pro feature (*Anti-Symmetry*). That way, only a quarter of structure is modeled (Fig. 2), which significantly reduces memory requirements and speed-up simulation.

Radiation pattern in 3D and a phi-cut are given in Figs 4-5, respectively. We can observe relatively high directivity and low side-lobes.

Distribution of near field is shown in Fig. 6. The physics of the lens antenna is effectively illustrated in this figure, where we can clearly see the changing direction of the EM wave as the result of the hyperboloidal lens.

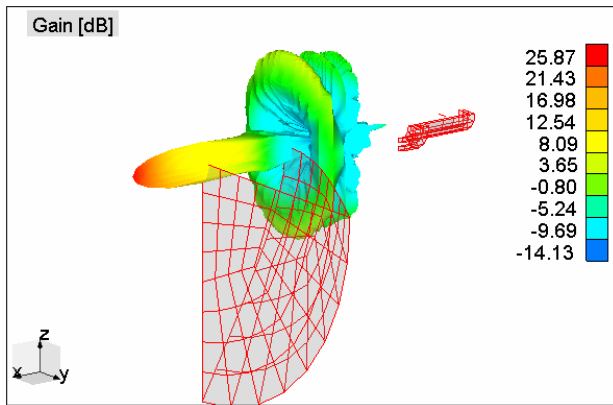

Figure 4. Radiation pattern in 3D

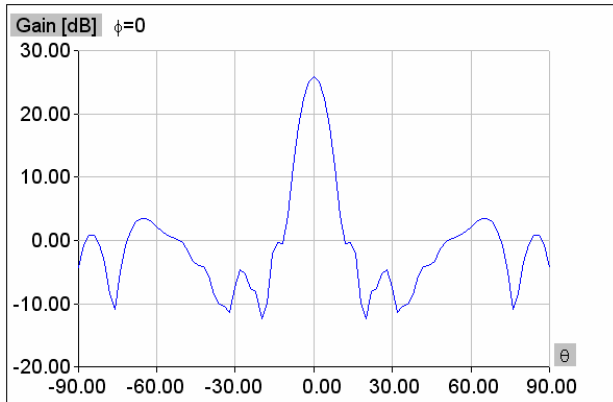

Figure 5. Radiation pattern in phi-cut

Number of unknowns and simulation time at a single frequency are given in Tab. 1. Computer used for these calculations is Intel® Xeon® CPU E5345 @ 2.33 GHz 8 GB RAM is used.

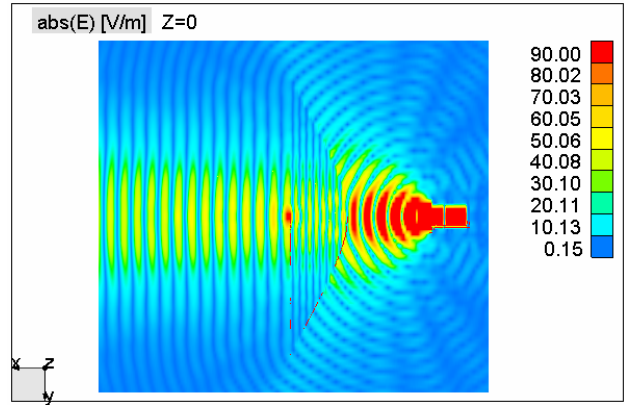

Figure 6. Near field

Table 1. Analysis characteristics

Number of unknowns	Memory [MB]	Time [min]
3170	80.4	9.1

Conclusion

This kind of antenna is usually simulated using geometrical optics methods. However, WIPL-D Pro successfully analyses that antenna using MoM thanks to sophisticated techniques such as higher order basis functions. Simulation times are very short comparing to other computational methods of similar accuracy. This makes WIPL-D Pro an excellent tool for tackling very challenging lens antenna designs.

Results given here by WIPL-D Pro coincide with theoretical expectations.